

Colposcope, stands, additional equipment



1E LED Light

1E LED

1D LED

1DW LED

1DS LED

3MVC LED USB

3MVCS LED USB

3MVCW LED USB

3ML LED

3MLW LED

3MLS LED 1"

3MLS LED 1/2"

3MVS LED Y/C NTSC

Service Manual

Assembly

Repair

Spare parts

English



Publication details

Copyright ©LEISEGANG Feinmechanik-Optik GmbH 2013.

All rights, delivery availability and technical changes reserved.

LeiseCap, ColpoSoft and ColpoViewer are brands from LEISEGANG Feinmechanik-Optik GmbH. Other product and company names mentioned in this documentation may be brands or company names of their respective owners.

Issued by:

LEISEGANG Feinmechanik-Optik GmbH
Leibnizstrasse 32
D-10625 Berlin

Phone: +49 30 319 009-0

Fax: +49 30 313 5992

E-Mail: info@leisegang.de

www.leisegang.de



Please read the instructions and information in the Instructions for Use carefully before using the device.

Contents

1	Purpose	5
1.1	Intended use	5
1.2	Indications and field of application.....	5
1.3	Users and application environment.....	6
1.4	Contraindications	6
1.5	Adverse effects	6
1.6	General user information	6
1.7	Safety instructions.....	7
1.7.1	Meaning of symbols in these instructions.....	7
1.7.2	Meaning of symbols on the device and outer packaging	7
1.7.3	Precautions and safety information	8
2	Marketability.....	9
2.1	Medical device and market placement	9
2.2	Warranty information.....	9
3	Device description.....	10
3.1	Essential features	10
3.2	Colposcope	10
3.3	Stand	13
4	Technical data.....	15
4.1	General information.....	15
4.2	Power supply.....	15
4.3	Standard colposcope	16
4.4	Photo/video colposcope	18
4.5	Stand	20
4.6	5-wheeled spider base.....	21
4.7	Special mounts	22
4.8	Additional equipment	23
4.8.1	Tray 23	
4.8.2	Support arm for panel PC MWS.....	24
4.8.3	Keyboard holder for panel PC MWS	24
4.8.4	Panel PC MWS.....	25
4.8.5	Footswitch.....	26
4.8.6	Software MWS, LeiseCap and ColpoSoft	26
4.8.7	Cameras	27
4.8.8	Tubes.....	28
4.8.9	Photo/video adapter	28
4.9	Model number	29
4.10	Electromagnetic compatibility.....	30

5	Transport and storage.....	34
5.1	Storage.....	34
5.2	Disposal of packaging material.....	34
6	Assembly.....	35
6.1	Mounting on spider base	35
6.1.1	Upright stand	35
6.1.2	Swing-o-matic stand	37
6.1.3	Balance-o-matic stand.....	40
6.1.4	Left assembly.....	43
6.2	Chair mounting	47
6.3	Chair mounting – left assembly	53
6.4	Conversion from chair to spider base mounting	53
6.5	Special mounts	54
6.6	Tray.....	55
6.7	Support arm panel PC MWS for chair / spider base mounting	56
6.8	Keyboard holder for panel PC	56
6.9	1E LED Light – tilt handle.....	56
6.10	Cameras for 3ML LED.....	57
6.10.1	Video camera.....	57
6.10.2	Canon EOS digital single lens reflex camera.....	58
6.11	Photo/video adapter	61
7	Care, maintenance, inspection.....	64
7.1	Care	64
7.2	Maintenance	66
7.3	Inspection	66
8	Repair	67
8.1	Replacing the tension wire (cable pull) on the spider base	67
8.2	Replacing the eyepiece cap upper parts.....	72
8.3	Replacing the fuse in the power supply	72
9	Spare parts.....	73
10	Disposing of waste equipment.....	73
11	Customer service	74
12	Keyword index	75

1 Purpose

1.1 Intended use

Leisegang colposcopes are used in gynaecological examinations for magnified, non-contacting viewing of the external female genitalia (vulva, vagina, portio). The colposcopes may also serve for magnified, contactless viewing of other external organs.

Leisegang photo/video colposcopes with integrated or externally connected camera can also be used to document the finding.

Leisegang colposcopes only serve diagnostic purposes. Leisegang Feinmechanik-Optik GmbH recommends taking further cytological findings into account for diagnosis.

1.2 Indications and field of application

Leisegang colposcopes are used in gynaecological examinations for magnified, non-contacting viewing of the external female genitalia (vulva, vagina, portio).

Colposcopy – cytological findings:

- Suspicion of carcinoma
- Suspicion of low or high-grade dysplasia (deviation of the tissue structure from the normal image)
- Glandular atypia (glandular, possibly inflammatory epithelium atypia (deviations from the norm) that do not fulfil the criteria for dysplasia)
- Unclear findings from cytological smears (Pap smear, thin-layer cytology)
- Abnormal smear test findings in patients who suffer from immunosuppression (suppression of the body's immune defenses), for example due to HIV infection or after organ transplantation

Colposcopy – other findings:

- Proven infection with HPV (human papillomavirus: Viruses that can cause cervical cancer)
- Contact bleeding (bleeding on mucosal contact, e.g. following sexual intercourse)
- Persistent vaginal discharge
- Macroscopic conspicuous cervix (changes visible to the naked eye)
- Cervical polyps (benign protrusions of the mucous membrane in the cervical - canal)

1.3 Users and application environment

Users

User group	Qualification	Activity
End user: doctors	Specialist in gynaecology	Operating the device
End user: medical staff	Professional training in healthcare	Device maintenance
Medical technicians, medical technology dealers	Electrical engineering specialist training	Assembly of the device
Medical technicians, medical technology dealers	Electrical engineering specialist training and authorisation from Leisegang	Assembly of the device and repairs according to training and authorisation from Leisegang

Application environment

Leisegang colposcopes are only intended for use in rooms used for medical purposes.



Observe the local requirements for the electrical installation.

1.4 Contraindications

There are no known contraindications to the use of Leisegang colposcopes.

1.5 Adverse effects

There are no known adverse effects for the use of Leisegang colposcopes.

1.6 General user information



This Service Manual describes the assembly and repair of Leisegang colposcopes. The operation of colposcopes is described in the Instructions for Use.

Highlighting





















Highlighting	Function	Example
<i>Italics</i>	Reference to other sections or text passages	Please note the instructions as listed under <i>Chassis of colposcope head</i> .
Bold	Reference numbers for illustrations; for emphasis	(1)

1.7 Safety instructions

1.7.1 Meaning of symbols in these instructions

Symbol	Meaning
	Necessary information for the subsequent steps; information and tips
	Safety notice "Caution" Warns of a danger that can lead to minor physical injuries or damage to property.
	Safety notice "Warning" Warns of a danger that can lead to serious physical injuries or to death.

1.7.2 Meaning of symbols on the device and outer packaging

Symbol	Meaning	Symbol	Meaning
	Conformity of the product with the provisions of the applicable EU directive (and national laws)		Conformity of the product with US and Canadian safety requirements.
	Manufacturer's address		Date of manufacture
	Serial number of the product		Model number of the product
	Transport and store dry		Fragile; transport with store care, do not drop
	Permissible humidity range during transport and storage		Permissible temperature range during transport and storage
	Permissible temperature range during transport and storage		Protection type; protection against the ingress of solid foreign bodies and water
	Transport and store with the arrows always point up		Electromagnetic interference can occur in the vicinity of devices labelled this way
	Recycling of the packaging material		Separate disposal of waste electrical-equipment
	Observe Instructions for Use		Generic device designation in accordance with Global Medical Device Nomenclature (GMDN)
	Alternating current		Direct current
	Protection class II		

1.7.3 Precautions and safety information

Read the following safety information carefully before installation and use:



- These instructions are part of the device and must be kept throughout the entire service life of the product.
- Keep these instructions available for reference and pass them on to the next user of the device.
- Observe the practically-oriented safety instructions in the relevant sections.
- Only use the colposcope with Leisegang stands and Leisegang accessories.
- Dirt and dust can impair the functionality of the device. Therefore protect the device when not in use with the dust protection cover supplied. Before covering the device, check that it is switched off.
- There is a risk of crushing when adjusting the height of the colposcope head and swing-o-matic stand. Therefore, observe the safety instructions in the relevant sections.
- The connecting tube of the colposcope must always be inserted at least 20 cm in the stand frame in order to ensure stability.
- Waste electrical and electronic equipment must not be discarded with household rubbish. Dispose of your old equipment in accordance with national requirements for separate disposal of waste or return your old device either to your supplier or Leisegang Feinmechanik-Optik GmbH.



- The device may only be operated in dry rooms without spray water.
- The device must not be operated in an oxygen-saturated environment.
- Set-up the device in a stable position.
- Do not roll the device over cables and tubes on the floor.
- Do not hang any additional objects on the device that are not expressly intended for this purpose.
- Do not lean against the device.
- Do not cover the cooling slots of the power supply or the cooling slots of the LED light source. This can cause overheating and damage to the device.
- Position the device in a way to allow easy access to the mains cable.
- Only pull the mains cable from the socket at the plug.
- Never remove the ferrite beads from the USB cables, since this may cause electromagnetic interference.
- Do not operate power supplies, mains cables, lamp cables or mains plugs or with mechanical damage. Defective parts must be replaced by qualified, authorised specialist personnel. Contact your supplier in this regard.
- Do not undertake any modifications, as otherwise safe operation of the device is not guaranteed and all guarantee and warranty claims towards Leisegang Feinmechanik-Optik GmbH are void.
- Always unplug the device from the mains socket before changing the fuse and before cleaning the device.
- The power supply is not drip or splash-proof. The ingress of water result in an electric shock. For this reason, when cleaning the device ensure that no dripping water comes into contact with it. No infusion devices, e.g. infusion bags, bottles and lines may be installed above the colposcope that entail a risk of dripping.

2 Marketability

2.1 Medical device and market placement

According to Annex IX of the *93/42/EEC Medical Devices Directive*, Leisegang colposcopes are class I medical devices.

In a conformity assessment procedure in accordance with Annex VII of the Medical Device Directive, Leisegang Feinmechanik-Optik GmbH demonstrated that the Leisegang colposcopes fulfil the basic requirements of Annex I of the directive.

The devices bear the CE mark to indicate compliance with these requirements. A copy of the Declaration of the Conformity is included with each colposcope delivered for the first time.

2.2 Warranty information

Leisegang Feinmechanik-Optik GmbH can only guarantee the safety, reliability and performance of Leisegang colposcopes if the user observes the instructions in this Service Manual.

The warranty covers the repair or replacement of defective parts insofar as these defects are based on the manufacture or the material.

The following actions void the warranty with immediate effect:

- Use of the colposcope other than for its intended purpose
- Improper operation of the colposcope system
- Defects or equipment failures caused by improper operation or normal wear
- Modifications or repairs to the colposcope by unauthorised persons
- Non-compliance with the applicable standards concerning electrical installations.

3 Device description

3.1 Essential features

All Leisegang colposcopes offer the following features:

- Convergent beam path; the beam paths converge at a working distance of 300 mm
- 300 mm working distance
- Green filter for viewing vessels (apart from angled devices)
- Compensation of refractive errors through adjustable eyepieces
- LED lighting with an illumination intensity of 45,000-52,000 lx¹ and a colour temperature between 5,700-6,000 K,
- Leisegang colposcopes are designed for a service life of 10 years.

3.2 Colposcope

Front



1	Magnification changer
2	Horizontal drive
3	Connecting tube
4	Vertical drive
5	Thread for mounting plate
6	Front lenses
7	Lamp optics

Rear



8	LED illumination unit
9	Green filter
10	Clamp nut for tilt adjustment
11	Lamp cable
12	Eyepieces
13	Prism bodies

¹ 23,000-35,000 lx in S-devices (magnification: 3.75x/7.5x/15x)

Colposcope type plate		
Model number	COLPOSCOPE	Device designation
Serial number	REF 3MVC - 221112	CE mark
Manufacturer	SN 13-071000	Date of manufacture
	Leisegang GmbH	Input
	Leibnizstr. 32, D-10625 Berlin	Separate disposal of waste electrical equipment

Power supply



WARNING

Injury through electric shock

The use of a third-party power supply can result in an electric shock.

- The colposcope models listed above must only be operated with the stated power supplies!

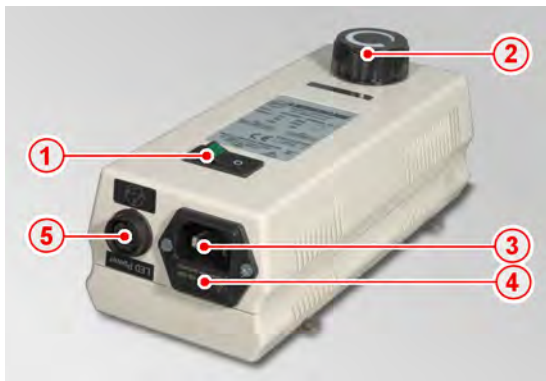

1	On/off switch
2	Brightness control
3	Connection for the mains cable
4	Fuse holder
5	Connector socket with bayonetlock for the lamp cable

Device description

► Colposcope

Power supply type plate

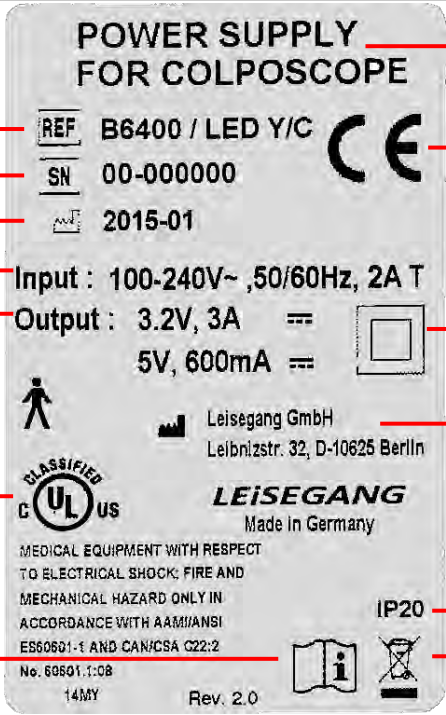

The image shows a rectangular power supply type plate with the following text and markings:

- POWER SUPPLY FOR COLPSCOPE** (Device designation)
- REF B6400 / LED Y/C** (Model number)
- SN 00-000000** (Serial number)
- 2015-01** (Date of manufacture)
- Input : 100-240V~ ,50/60Hz, 2A T** (Input)
- Output : 3.2V, 3A** and **5V, 600mA** (Output)
- CE mark** (CE mark)
- Protection class II** (Protection class II)
- Leisegang GmbH**, **Leibnizstr. 32, D-10625 Berlin** (Manufacturer)
- UL mark** (UL mark)
- LEISEGANG**, **Made in Germany** (Manufacturer name and origin)
- IP20** (Protection type)
- Observe the instructions for use** (Instruction to read manual)
- Separate disposal of waste electrical equipment** (Waste disposal symbol)
- MEDICAL EQUIPMENT WITH RESPECT TO ELECTRICAL SHOCK; FIRE AND MECHANICAL HAZARD ONLY IN ACCORDANCE WITH AAMI/ANSI ES60601-1 AND CAN/CSA C22:2** (Safety warning)
- No. 69591.1:08**, **14MY**, **Rev. 2.0** (Version and date information)

3.3 Stand

Swing-o-matic stand



1	Star knob screw
2	Spider base column
3	Clamp flange
4	Supporting ring with latch pin
5	Conical insert
6	5-wheeled spider base with counterweight
7	Frame
8	Clamp nut for clamp head
9	Power supply

Balance-o-matic stand



1	Circular spirit level
2	Column for balance-o-matic stand
3	Spring shaft
4	Clamp pair
5	Adjusting collar for tension spring
6	5-wheeled spider base with counterweight
7	Conical insert
8	Frame
9	Clamp nut for clamp head
10	Power supply
11	Clamping lever

Device description

► Stand

Upright stand





1	Clamp nut for clamp head
2	Power supply
3	Cable outlet
4	Stand column
5	5-wheeled spider base

4 Technical data

4.1 General information

Operational data	
Usage type	Not suitable for use in an oxygen-enriched environment
Operating mode	Suitable for continuous operation
Applied parts	The device has no applied parts that come into direct contact with the patient
Working distance	300 mm
Environmental and storage conditions	
Ambient temperature	10-45 °C
Relative humidity	30-75%, non-condensing
Air pressure	700-1,060 hPa
Storage	Dry, cool, protected against dripping water, non-condensing

4.2 Power supply

Power supply REF B 6400 / LED Y/C		
Input	100-240 V ~ 2 A _{max} , 50/60 Hz	
Output	3.2 V  3 A _{max}	
	5 V  600 mA _{max}	
Protection against electric shock	 Protection class II	
Protection against harmful ingress of solids and liquids	IP 20	
Integrated illumination		
	With magnification	
	3.75x/7.5x/15x	7.5x/15x/30x
Light source	LED	
Power consumption	10 W	
Colour temperature T _F	5,700-6,000 K	
Illumination intensity E _V (at a distance of 300 mm)	23,000-35,000 lx	45,000-52,000 lx
Illuminated field diameter	78 mm	58 mm
Field of view diameter	76/38/19 mm	46/23/11.5 mm

4.3 Standard colposcope

1E LED Light



1E LED



Model	1E LED Light		1E LED	
Mechanical data				
Weight	1.85 kg		2.75 kg	
Dimensions H x W x D	564 x 125 x 205 mm		605 x 135 x 205 mm	
Configuration				
Magnification	7.5x	–	–	
	15x	●	●	
	30x	–	–	
Dioptré compensation (±7 dioptré)	●		●	
Horizontal and vertical fine adjustment	–		●	
Green filter	●		●	
45° angled view	–		–	

1D LED



1DW LED



Model		1D LED ²	1DW LED
Mechanical data			
Weight		3.00 kg	3.10 kg
Dimensions H x W x D		605 x 135 x 205 mm	640 x 135 x 245 mm
Configuration			
Magnification	7.5x	●	●
	15x	●	●
	30x	●	●
Dioptré compensation (±7 dioptré)		●	●
Horizontal and vertical fine adjustment		●	●
Green filter		●	–
45° angled view		–	●

² Also available as S-device: 1DS LED (magnification: 3.75x/7.5x/15x)

4.4 Photo/video colposcope

3ML LED



3MVS LED Y/C NTSC



Model	3ML LED ³	3MLW LED	3MVS LED Y/C NTSC	
Mechanical data				
Weight	3.90 kg	4.05 kg	3.50 kg	
Dimensions H x W x D	660 x 135 x 210 mm	675 x 135 x 240 mm	605 x 135 x 205 mm	
Configuration				
Magnification	3.75x	–	–	●
	7.5x	●	●	●
	15x	●	●	●
	30x	●	●	–
Diopre compensation (±7 diopre)	●	●	●	
Horizontal and vertical fine adjustment	●	●	●	
Green filter	●	–	●	
45° angled view	–	●	–	
Video camera, integrated	–	–	●	
Video camera, external	●	●	–	
DSLR camera (e.g. Canon EOS)	●	●	–	

³ Also available as S-devices: 3MLS LED 1", 3MLS LED 1/2" (magnification: 3.75x/7.5x/15x)

3MVC LED USB



3MVCW LED USB



Model	3MVC LED USB ⁴	3MVCW LED USB	
Mechanical data			
Weight	3.25 kg	3.60 kg	
Dimensions H x W x D	625 x 135 x 195 mm	630 x 135 x 245 mm	
Configuration			
Magnification	7.5x	●	●
	15x	●	●
	30x	●	●
Dioptré compensation (±7 dioptré)	●	●	
Horizontal and vertical fine adjustment	●	●	
Green filter	●	–	
45° angled view	–	●	
Video camera, integrated	●	●	
Video camera, external	–	–	
DSLR camera (Canon EOS)	–	–	

⁴ Also available as S-device: 3MVCS LED USB (magnification: 3.75x/7.5x/15x)

4.5 Stand



Model	Upright stand	Swing-o-matic stand	Balance-o-matic stand
Mechanical data			
Weight (without spider base)	1.75 kg	5.00 kg	7.90 kg
Dimensions H x W_{max}	670 x 120 mm	680 x 640 mm	750 x 715 mm
Horizontal movement	– (rigid column)	freely rotating in a radius of 600 mm	swinging freely in a radius of 600 mm
Vertical movement	– (manually lockable)	– (manually lockable)	balanced zero-force-movement, lockable
Working height	970-1090 mm (manually lockable)	947-1267 mm (manually lockable)	780-1200 mm (two-stage locking mechanism)
Configuration			
Chair mounting (right/left)	–	●	●
Assembly of the 5-wheeled spider base	Only with a lightweight 5-wheeled spider base (without counterweight), with 2 lockable castors	●	●

4.6 5-wheeled spider base



Model	Heavy 5-wheeled spider base
Weight	25.00 kg (incl. counterweight)
Diameter	650 mm
Castors	Universal castors for all floors, 5 lockable castors

4.7 Special mounts

Maquet (for swing-o-matic)



Maquet (for balance-o-matic)

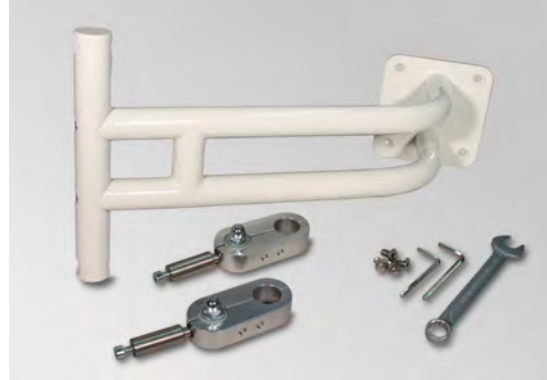

**Atmos Chair Gyne (Baisch)
(for swing-o-matic or balance-o-matic)**



Model	Maquet (for swing-o-matic)	Maquet (for balance-o- matic)	Atmos Chair Gyne (Baisch) (for swing-o-matic or balance-o-matic)
Weight	5.30 kg	5.20 kg	2.17 kg
Dimensions (H x W x D)	285 x 720 x 495 mm	310 x 740 x 390 mm	305 x 295 x 50 mm
Chair mounting (right/left)	●	●	●



In the case of other models of examination chair, the respective chair manufacturer is responsible for the mounting device.

4.8 Additional equipment⁵

4.8.1 Tray

Tray with 2-joint articulated arm⁶



Tray with 3-joint articulated arm⁶

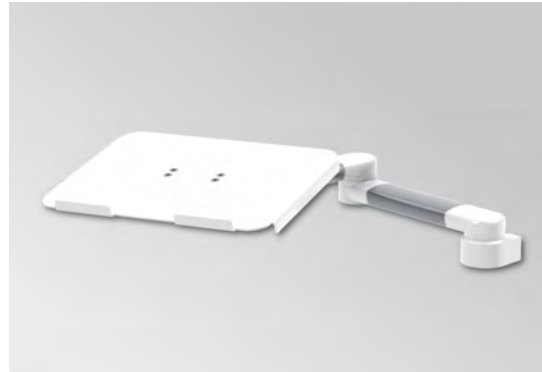

Model	Tray 2-joint ⁷	Tray 3-joint ⁷
Weight	4.70 kg	7.50 kg
Dimensions of supporting surface (W x H)	370 x 290 mm	289 x 366 mm
Total arm length	290 mm	731 mm
Mounting on swing-o-matic stand	●	●
Mounting on balance-o-matic stand	●	●

⁵ Third-party manufacturers

⁶ Similar to illustration

⁷ Only of limited suitability for chair mounting on swing-o-matic stand.

4.8.2 Support arm for panel PC MWS

Support arm for mounting on spider base⁸



Support arm for chair mounting⁸



Model	Support arm for mounting on spider base, for swing-o-matic or balance-o-matic stand ⁹	Support arm for chair mounting, for swing-o-matic or balance-o-matic stand ⁹
Weight	3.50 kg	5.50 kg
Total arm length	576 mm	806 mm
Mounting on swing-o-matic stand	●	●
Mounting on balance-o-matic stand	●	●



For chair mounting, a load-bearing capacity of 32 kg is required.

4.8.3 Keyboard holder for panel PC MWS

Holder for keyboard⁸

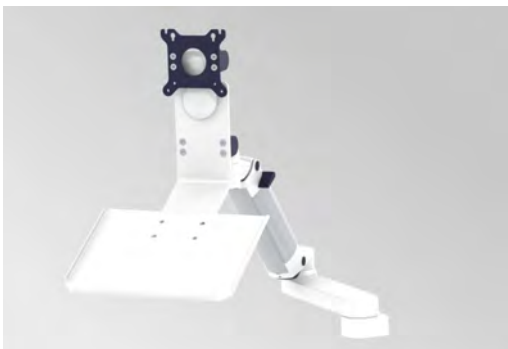

Model	Holder for keyboard
Weight	7.50 kg
Dimensions of supporting surface (W x H)	400 x 150 mm

⁸ Similar to illustration

⁹ Only of limited suitability for chair mounting on swing-o-matic stand



Additional mounting of a keyboard holder is not possible when mounting the support arm on a Swing-o-matic stand on a spider base.

4.8.4 Panel PC MWS

Panel PC MWS¹⁰



Model	Panel PC MWS
Weight	9.60 kg
Dimensions (H x W x D)	376 x 530 x 60 mm
Conformity to standards	DIN EN 60601-1, DIN EN 60601-1-2007
Protection against electric shock	 Protection class I
Protection against harmfulness of solids and liquids	IP20

¹⁰ Similar to illustration

4.8.5 Footswitch

Footswitch for LeiseCap and ColpoSoft¹¹



Footswitch for MWS software¹¹



Model	Footswitch for LeiseCap and ColpoSoft	Footswitch for MWS software
Weight	309 g	642 g
Dimensions (L x W x H)	196 x 100.5 x 45.5 mm	175 x 220 x 45 mm
Number of pedals	1	2
Cable length	2 m	3 m
Interfaces	1 x USB 2.0	1 x USB 2.0
RoHS compliant	●	●

4.8.6 Software MWS, LeiseCap and ColpoSoft



Please consult the Instructions for Use enclosed with the respective product for the technical data of the LeiseCap, ColpoSoft and MWS software.

¹¹ Similar to illustration

4.8.7 Cameras

Digital single lens reflex camera¹²



Video camera¹²



Model	Canon EOS digital single lens reflex camera	Video camera
Weight	530 g (only housing)	37 g
Dimensions (W x H x D)	128.8 x 97.3 x 62 mm	44 x 41 x 25.5 mm
Electrical supply	1 lithium-ion battery or mains operation	Mini-USB 2.0
Image sensor	CMOS	ICX445 1/3" EXview HAD CCD
Maximum resolution	Minimum 18 MP	Minimum 1.3 MP / 1296 (H) x 964 (V)
Frame rate	Minimum 30 B/s	Minimum 18 B/s
Interfaces	<ul style="list-style-type: none"> • Hi-Speed Mini USB type A to USB type A; video output (PAL/NTSC) integrated • HDMI mini type C (Out) 	<ul style="list-style-type: none"> • 1 x Mini-B USB 2.0 • 1 x General Purpose I/O
Threaded connection	Bayonet	C-mount

¹² Similar to illustration

4.8.8 Tubes

Photo tube



Video tube

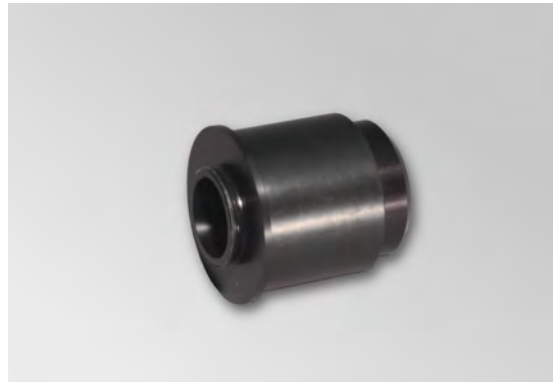

Model	Photo tube	C-mount video tube
Weight	65 g	87 g
Dimensions (Ø)	41 mm	41 mm
Threaded connection	Bayonet	C-mount

4.8.9 Photo/video adapter



Model	VID (for standard colposcopes)	
Mechanical data		
Weight	409 g	
Dimensions (L x W x H)	163 x 75 x 48 mm	
Configuration		
Magnification	3.75x	–
	7.5x	–
	15x	●
	30x	–

4.9 Model number

The model number (**REF**) comprises the following categories:

		Eyepiece view		Magnification			Head adjustment		Illumination	Camera interface			Chip size				
Digit		1		2			3		4	5			6				
	Model designation	Straight	45° tilted	1 15x	D 7.5/15/30x	S 3.75/7.5/15x	Fine	Only tilt	LED	--	USB	Y/C NTSC	--	1/4"	1/3"	1/2"	1"
Code	XXX –	1	2	1	2	3	1	2	1	0	1	3	0	1	2	3	5

Example:	1D-121100	1			2		1		1		0			0			
-----------------	------------------	----------	--	--	----------	--	----------	--	----------	--	----------	--	--	----------	--	--	--

The example shown reflects the model designation for a model 1D LED device with the following features:

- Digit 1: straight insight
- Digit 2: 7.5/15/30x magnification
- Digit 3: Option to fine adjust height, tilt and sharpness
- Digit 4: LED-Lighting
- Digit 5: Without camera interface
- Digit 6: Without chip

4.10 Electromagnetic compatibility

Leisegang colposcopes are intended for use in an environment that meets the electromagnetic specifications below.

Leisegang colposcopes have been designed to withstand the effects of electromagnetic interference (EMI) and meet the latest EMC standards. However, extremely high levels of electromagnetic energy (above the levels specified in IEC 60601-1-2) may still cause interference.

In order to reduce the risk of EMI, follow these recommendations:

- Do not turn on or use mobile communication devices, such as mobile two-way radios or mobile phones, in the proximity of the device. If the use of such equipment is required, please observe the information on 'recommended distance' in the following tables.
- In the event of unexplained EMI, check if there are any transmitters, such as radio or TV stations, located nearby. Either the location of the device may need to be changed or shielding between the transmitter and the device may need to be installed.
- We would like to point out that modification of the device or the addition of accessories or components could make the device more susceptible to the interference of high frequency waves.

Table 1:
Guidance and manufacturer's declaration - electromagnetic radiation

Leisegang colposcopes are intended for use in the electromagnetic environment specified below. The user of a Leisegang colposcope must ensure that the device is being operated in such an environment.

Emissions test	Compliance	Electromagnetic environment - guidance
RF emissions CISPR 11	Group 1	Leisegang colposcopes use RF energy only for internal functions. The RF emissions are therefore very low and are not likely to cause any interference in nearby electronic equipment.
RF emissions CISPR 11	Class B	Leisegang colposcopes are suitable for use in all environments, including domestic establishments and those directly connected to the public low-voltage power supply network that supplies buildings used for domestic purposes.
Harmonic emissions IEC 61000-3-2	Class A	
Voltage fluctuations/ flicker emissions IEC 61000-3-3	Complies	

Table 2:
Guidance and manufacturer's declaration - electromagnetic immunity

Leisegang colposcopes are intended for use in the electromagnetic environment specified below. The user of a Leisegang colposcope must ensure that the device is being operated in such an environment.

Immunity test	IEC 60601 test level	Compliance level	Electromagnetic environment - guidance
Electrostatic discharge (ESD)	±6 kV contact	±6 kV contact	Floors should be wood, concrete or ceramic tile. If floors are covered with synthetic material, the relative humidity should be at least 30%.
IEC 61000-4-2	±8 kV air	±8 kV air	
Fast electrical transients/bursts	±2 kV for power supply lines	±2 kV for power supply lines	The main power supply should correspond to that of a typical commercial facility or a hospital.
IEC 61000-4-4	±1 kV for input/output lines	±1 kV for input/output lines	
Surge voltage	±1 kV differential mode	±1 kV differential mode	The main power supply should correspond to that of a typical commercial facility or a hospital.
IEC 61000-4-5	±2 kV normal mode	±2 kV normal mode	
Voltage dips, short-interruptions and voltage variations at power supply input lines IEC 61000-4-11	<5% <i>UT</i> (>95% dip in <i>UT</i>) for 0.5 cycles	<5% <i>UT</i> (>95% dip in <i>UT</i>) for 0.5 cycles	The main power supply should correspond to that of a typical commercial facility or a hospital. If the user of a Leisegang colposcope requires continued operation during power mains interruptions, it is recommended that the Leisegang colposcope is powered by an uninterruptible power supply or a battery.
	<40% <i>UT</i> (>60% dip in <i>UT</i>) for 5 cycles	<40% <i>UT</i> (>60% dip in <i>UT</i>) for 5 cycles	
	<70% <i>UT</i> (>30% dip in <i>UT</i>) for 25 cycles	<70% <i>UT</i> (>30% dip in <i>UT</i>) for 25 cycles	
	<5% <i>UT</i> (>95% dip in <i>UT</i>) for 5 seconds	<5% <i>UT</i> (>95% dip in <i>UT</i>) for 5 seconds	
Mains frequency (50/60 Hz) magnetic field IEC 61000-4-8	3 A/m	3 A/m	The magnetic fields of mains frequency should be within a range that is characteristic for a typical commercial environment or in the environment of a hospital.

Note: *UT* is the AC voltage prior to the application of the test level.

Table 3:
Guidance and manufacturer's declaration - electromagnetic immunity

Leisegang colposcopes are intended for use in the electromagnetic environment specified below. The user of a Leisegang colposcope must ensure that the device is being operated in such an environment.

Immunity test	IEC 60601 test level	Compliance level	Electromagnetic environment - guidance
Conducted HF IEC 61000-4-6 Radiated RF IEC 61000-4-3	3 Vrms 150 kHz to 80 MHz 3 V/m to 2.5 GHz	3 V 3 V/m	<p>Portable and mobile RF communication equipment should not be used closer to parts of the Leisegang colposcope, including cables, as specified in the recommended distance. This is based on the valid formula for the frequency of the transmitter.</p> <p>Recommended distance:</p> $d = [3.5 / 3] \sqrt{P}$ $d = [3.5 / 3] \sqrt{P} \text{ 80 MHz to 800 MHz}$ $d = [7 / 3] \sqrt{P} \text{ 800 MHz to 2.5 GHz}$ <p>In this case P is the maximum output power rating of the transmitter in watts (W) according to the manufacturer of the transmitter; d is the recommended distance in meters (m).</p> <p>The field strength of the fixed RF transmitters, as determined by an electromagnetic site survey ^(a) should lie below the compliance level in each frequency range ^(b).</p> <p>Interference may occur in the vicinity of equipment marked with the following symbol: </p>
Note 1:	At 80 MHz and 800 MHz, the higher frequency applies.		
Note 2:	These guidelines may not apply in all situations. Electromagnetic propagation is affected by absorption and reflection from structures, objects and people.		
a)	The field strength of fixed transmitters, such as base stations for (mobile/cordless) phones and public land mobile radios, amateur radio, AM and FM-radio stations and TV-transmissions can, in theory, not be predicted accurately. In order to assess the electromagnetic environment due to fixed RF transmitters, a factory-made electromagnetic site survey is recommended. If the measured field strength in the location, in which the Leisegang colposcope is being operated, exceeds the above-mentioned RF compliance level, particular attention must be paid in order to guarantee a normal operation of the Leisegang colposcope. If an incorrect operation is observed, additional measures may be required, such as the realignment or relocation of the Leisegang colposcope.		
b)	Above the frequency range of 150 kHz to 80 MHz, the field strength should be less than 3 V/m.		

Table 4:
Recommended distance between portable/mobile RF communications device and a Leisegang colposcope - valid for equipment and systems not intended for life-sustaining applications

Leisegang colposcopes are for use in an electromagnetic environment in which radiated RF interference is monitored. The user of a Leisegang colposcope can help prevent electromagnetic interference by maintaining a minimum distance between the portable/mobile RF communications device (transmitter) and the Leisegang colposcope as recommended below; this minimum distance is determined by the maximum output power of the communications device.

Maximum output-power of transmitter W	Distance according to frequency of transmitter m		
	150 kHz to 80 MHz $d = [3.5 / 3] \sqrt{P}$	80 MHz to 800 MHz $d = [3.5 / 3] \sqrt{P}$	800 MHz to 2.5 GHz $d = [7 / 3] \sqrt{P}$
0.01	0.12	0.12	0.23
0.1	0.37	0.37	0.74
1	1.2	1.2	2.3
10	3.7	3.7	7.4
100	12	12	23

For transmitters rated at a maximum output power not listed above, the recommended distance d in meters (m) can be estimated using the equation applicable to the frequency of the transmitter, where P is the maximum output power rating of the transmitter in watts (W) according to the transmitter manufacturer.

Note 1: At 80 MHz and 800 MHz, the higher frequency applies.

Note 2: These guidelines may not apply in all situations. Electromagnetic propagation is affected by absorption and reflection from structures, objects and people.

5 Transport and storage

5.1 Storage



- If the boxes are stored for a longer period of time, attention needs to be paid that the environmental conditions are dry, cool and non-condensing. The boxes must be stored protected against dripping water.
- Store the boxes on the correct side, according to the inscription 'Top'.

5.2 Disposal of packaging material



The packaging is made from recyclable materials and can be recycled. Use the country-specific waste disposal system.



We recommend storing the original box and packing material. If necessary, the device can be transported well protected at a later point in time.

6 Assembly



Always start with assembling the stand and only then insert the colposcope. This way the colposcope remains protected against unnecessary stresses.

6.1 Mounting on spider base

6.1.1 Upright stand



- The upright stand can only be mounted on a spider base; chair mounting is not possible.
- It is not possible to attach a panel PC.

1. Place the light spider base on the floor.
2. Insert the upright column with the insert for spider base into the spider base opening.



3. Place the stand carefully on its side.
4. Insert the hex (Allen) screw with washer into the underside of the spider base. Screw in the hex screw with the assembly key supplied. The screw must be tightened:

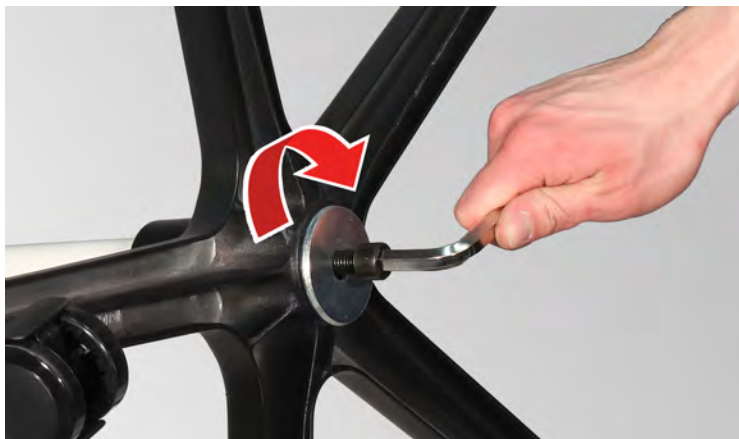

5. Position the stand upright.

Assembly

► Mounting on spider base

6. First of all, pass the colposcope lamp cable through the opening in the stand (1) and then insert the connecting tube. Ensure that the cable is fed out of the lower outlet (2):



7. Hold the colposcope at the height required as the working height and tighten the clamp nut on the clamp head:



8. Connect both the lamp cable and the mains cable to the power supply. Ensure that the lamp cable plug has a bayonet lock which first has to be inserted (3) and then locked (4):



- The upright stand is assembled.

6.1.2 Swing-o-matic stand



CAUTION

Risk of crushing through counterweight

The counterweight is heavy and can cause crushing injuries.

- ▶ Always work in pairs to assemble the Swing-o-matic stand!

1. Place the swing-o-matic stand on the floor. Ensure that the two frames form a stable angle to one another:

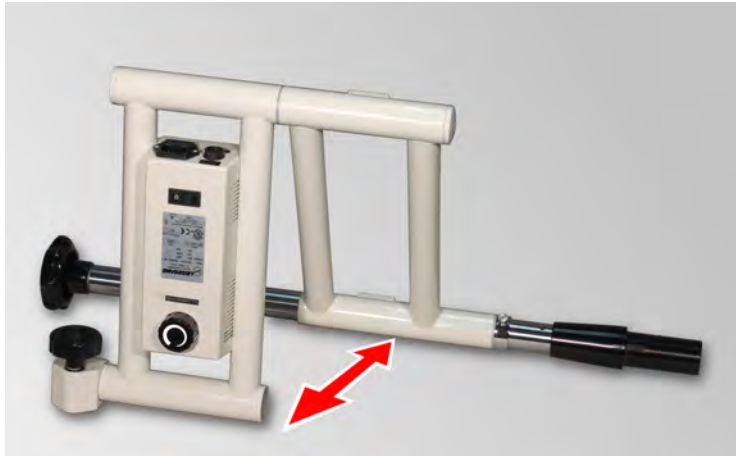

2. Attach the spider base to the conical insert of the spider base column (1).
3. Slide the cap over the counterweight and position it on the underside of the spider base. Screw in the hex screw with the assembly key supplied (2). The screw must be tightened:



With regard to the additional attachment of a panel PC, a spider base with a double counterweight must be mounted.

4. Position the stand upright.



The colposcope model 1E LED Light must first be prepared for mounting (see section 6.9 1E LED Light – tilt handle).
Continue with assembly at this point.

5. Pass the colposcope lamp cable through the opening in the stand (3). Insert the connecting tube and hold the colposcope at roughly the height required as the working height. Then tighten the clamp nut on the clamp head (4):



6. Connect both the lamp cable and the mains cable to the power supply. Ensure that the lamp cable plug has a bayonet lock which first has to be inserted (5) and then locked (6):
7. Fasten the lamp cable at the rear of the power supply using the cable ties (7). Bear in mind that you allow the cable sufficient play for height adjustment:

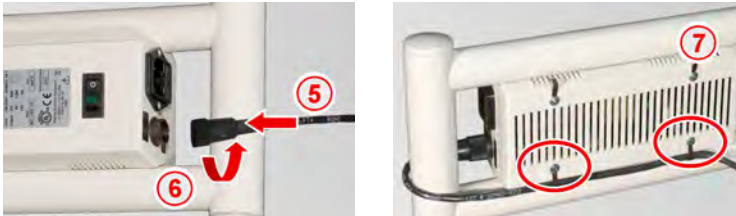

8. In order to perform precision adjustment of the working height, hold the stand frame and pull out the latch pin of the retaining ring (8). Move the retaining ring to the desired height and release the latch pin into the appropriate hole (9). Carefully set down the stand frame:



CAUTION

Risk of crushing through weight

The stand is heavy and can cause crushing injuries if dropped.

- Hold the stand frame when adjusting the working height until the supporting ring is locked in place.

9. Finally correct the free movement of the stand frame with the two clamping flanges by loosening or tightening the screws. It is best to use a coin for this purpose:

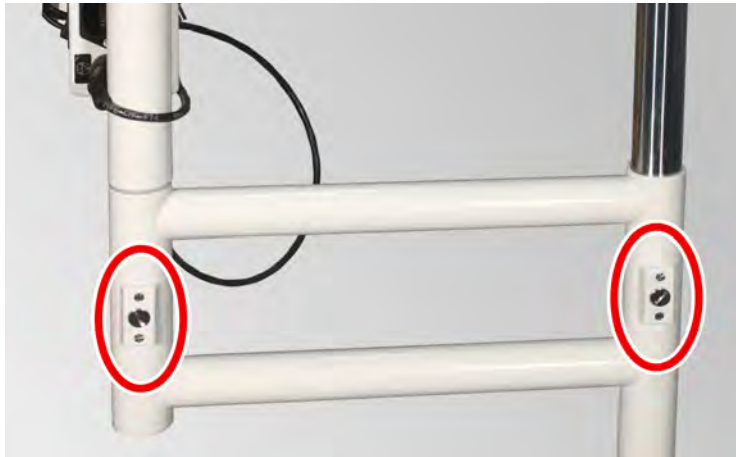

Note that the clamping flanges only have a slight braking effect and are not intended for fixed locking.

- ▶ The swing-o-matic stand is assembled.

6.1.3 Balance-o-matic stand



CAUTION

Risk of crushing through counterweight

The counterweight is heavy and can cause crushing injuries.

- Always work in pairs to assemble the balance-o-matic stand!

1. Place the balance-o-matic stand on the floor. Ensure that the two frames form a stable angle to one another:

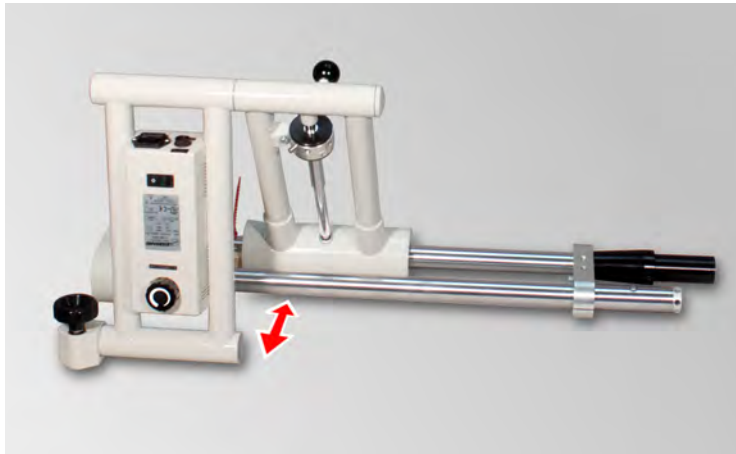

2. Attach the spider base to the conical insert of the spider base column (1).
3. Slide the cap over the counterweight and position it on the underside of the spider base. Screw in the hex screw with the assembly key supplied (2). The screw must be tightened:



- With regard to the additional attachment of a panel PC, a spider base with a double counterweight must be mounted.
- No additional keyboard can be installed in combination with a panel PC.

4. Position the stand upright.



The colposcope model 1E LED Light must first be prepared for mounting (see section 6.9 *1E LED Light – tilt handle*).

Continue with assembly at this point.

5. Pass the colposcope lamp cable through the opening in the stand (3). Insert the connecting tube and hold the colposcope at roughly the height required as the working height. Then tighten the clamp nut on the clamp head (4):



6. Connect both the lamp cable and the mains cable to the power supply. Ensure that the lamp cable plug has a bayonet lock which first has to be inserted (5) and then locked (6).
7. Fasten the lamp cable at the rear of the power supply using the cable ties (7). Bear in mind that you allow the cable sufficient play for height adjustment:



8. Ensure that the clamping lever of the height adjustment is locked:

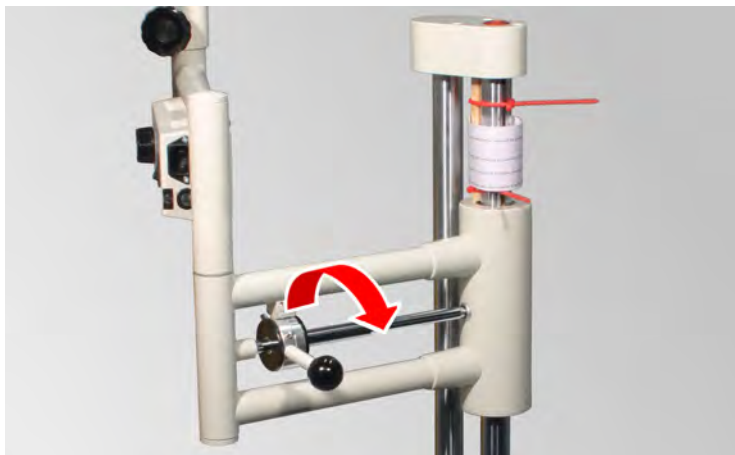



CAUTION

Risk of crushing through upward acceleration of the frame

The frame is under tensile stress. If the clamping lever is released, the frame can accelerate upwards.

- ▶ Firstly lock the clamping lever and then remove the spacer block.

9. Remove the spacer block and carefully release the clamping lever lock.



The tension of the tension springs is preset at the factory for weight compensation. Check the final tension nevertheless.

The tension is set correctly if the stand frame remains in a balanced state after removing the spacer block. If it still moves upwards, the tension has to be corrected.

10. Move the stand to the mid height for this purpose and lock the clamping lever.



CAUTION

Risk of crushing through weight

While setting the spring tensioning the hex key can slip and the stand frame can drop down or accelerate upwards.

- ▶ Therefore lock the stand frame before removing the latch pin.



To set the spring tensioning, a screwdriver can be also used instead of a hex key.

11. Insert the hex key into one of the holes in the adjusting collar. Push it through completely.

12. Turn the hex key anticlockwise slightly (8), hold the key in this position and pull out the latch pin (9):

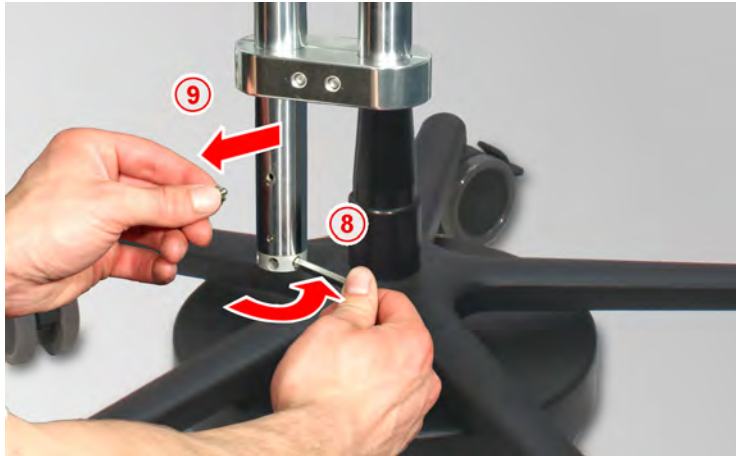

13. Now turn the adjusting collar about half a turn counter-clockwise or clockwise:
- ▶ **Anticlockwise:**
The tension is increased, the frame moves upwards.
 - ▶ **Clockwise:**
The tension is decreased, the frame moves downwards.
14. Reinsert the latching pin, release the clamping lever and check whether the tension is now set correctly. Repeat the procedure as necessary.
- ▶ The balance-o-matic stand is assembled.



In a non-active position or if outside the working position, the stand may be in what is referred to as the “park position” (folded-up). Up and down movement should be avoided in this position, as otherwise damage to the supports and the stand frame may result. Vertical movement may only be undertaken in the extended state.

6.1.4 Left assembly



Both the swing-o-matic and the balance-o-matic stands are factory prepared for right assembly. However, both stands may be left assembled as required.

Left assembly is described for the swing-o-matic stand. But the description applies analogously for the swing-o-matic stand.

Prerequisite:

- ▶ The spider base with counterweight is attached to the stand.
- ▶ The colposcope has **not** yet been inserted.

Assembly

► Mounting on spider base

1. Move the stand frame to the top position and lock the clamping lever:

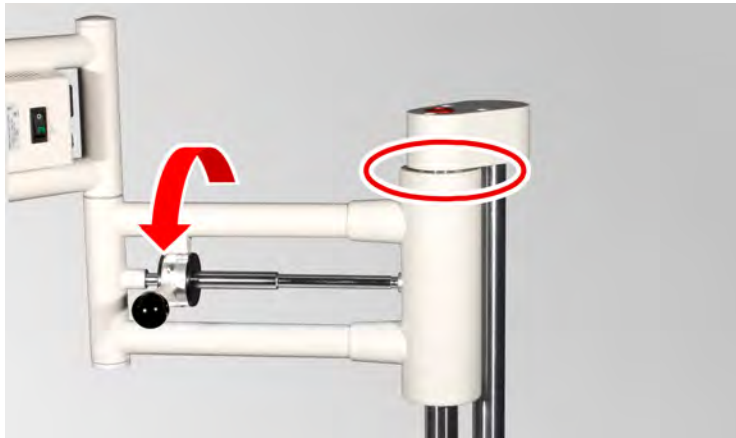

2. Release the clamp nut:



3. Pull out the clamp with bolts (1) and re-insert it the other way round (2):

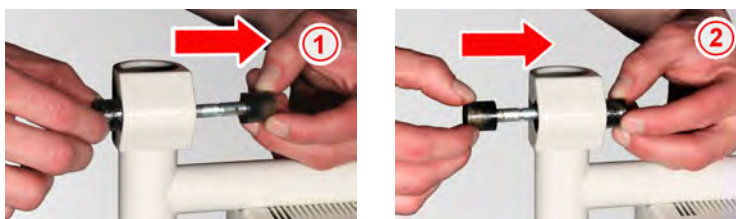

4. In doing so, ensure that the flat side points towards the opening in the stand (3). Screw the clamp nut back on again (4):

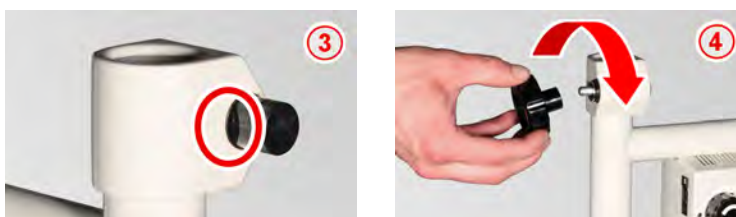



CAUTION

Damage to the opening on the stand due to overtightening

By tightening the clamp nut without the connecting tube inserted, the opening on the stand can be damaged.

- ▶ So never tighten the clamp nut if no connecting tube is inserted.



WARNING

Risk of injury through electric shock

Opening the power supply can lead to contact with live components.

- ▶ Therefore, before opening the power supply, ensure that the mains plug is pulled out of the socket.

5. Screw open the power supply with a screwdriver. Hold a hand under the power supply while doing this to prevent dropping:



6. Screw the two halves back together. Make sure to position the power supply centred in the frame:



7. Unscrew the ball knob from the clamping lever (5) and pull down the protective sleeve (6):



8. Unscrew the clamping lever using an assembly key (7) and screw it back onto the other side of the clamp (8):



9. Slip the protective sleeve back over and screw the ball knob back on:

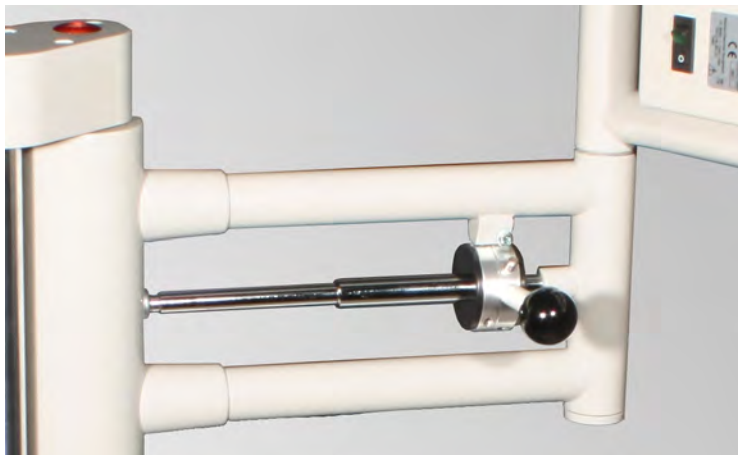

Ensure that the clamping lever is now locked upwards!

10. Now continue assembling the stand as described in sections 6.1.2 *Swing-o-matic stand* or 6.1.3 *Balance-o-matic stand*.

11. Set the height of the colposcope such that the handle for the vertical drive passes freely over the upper frame:



- The left assembly is complete.

6.2 Chair mounting



- Examination chairs from the companies Atmos (Baisch) and Maquet require special mounts, which are available from Leisegang. Please contact our customer service team in this regard (see section *11 Customer service*).
- The chair mounting for examination chairs from other companies, such as Schmitz, Aga, Medifa-Hesse, Eron, Promotal/Midmark etc. is supplied directly by the manufacturers. Please contact the respective chair manufacturer in this regard.



Abb. 1. Example: Schmitz chair mounting

Mounting of a balance-o-matic stand on a Schmitz examination chair is described. But the description applies analogously for the swing-o-matic stand.

1. Lower the examination chair to its end position.

2. Lock the clamping lever on the stand (1) and remove the spacer block (2):

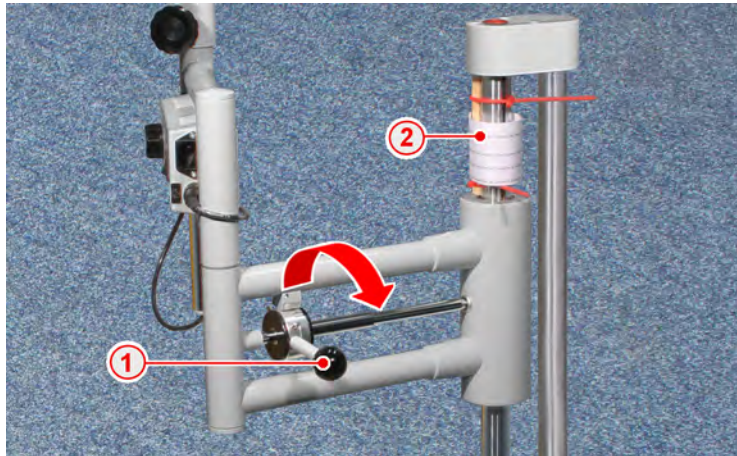

CAUTION

Risk of crushing through upward acceleration of the frame

The frame is under tensile stress. If the clamping lever is released, the frame can accelerate upwards.

- Firstly lock the clamping lever and then remove the spacer block.

3. Carefully release the clamping lever again, lock it in the uppermost position (3) and remove the lower clamp pair (4):

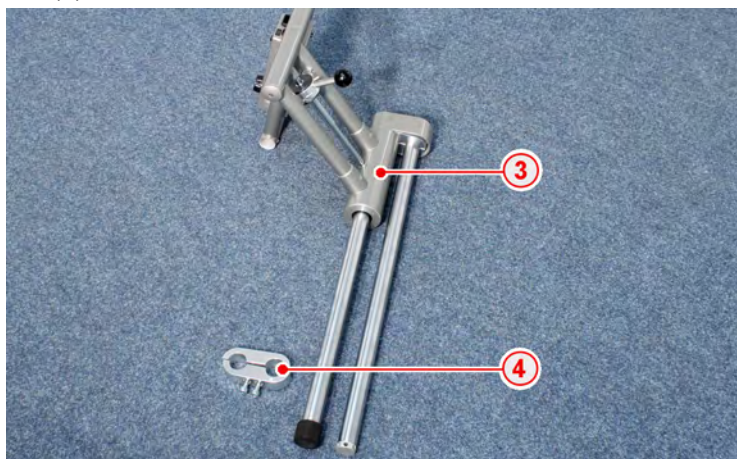

4. Pass the spring shaft tube through the two clamping jaws of the chair mounting. In doing so, ensure that the latch pin points towards the rear and is fed through the intended recess (5):



5. Turn the swing-o-matic column to the front so that both columns are aligned in a row with the clamping jaws (6). The distance between the columns and the floor must be at least 5 cm (7):

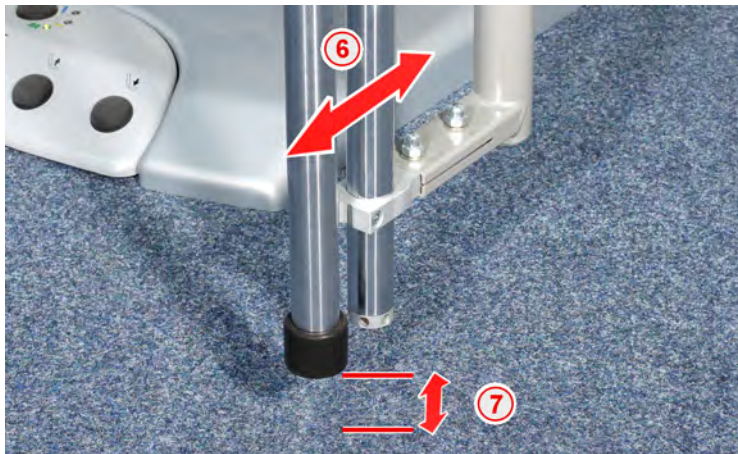

CAUTION

Risk of entrapment due to insufficient clearance

If the distance between the balance-o-matic stand and the floor is too low, feet can be trapped and crushed.

- Mount the stand in such a way that a distance of **at least 5 cm** from the floor is adhered to.

6. Tighten the screws on the clamping jaws (8). Screw on the clamp above the lower clamping jaw (9):



The colposcope model 1E LED Light must first be prepared for mounting (see section 6.9 1E LED Light – tilt handle).

Continue with assembly at this point.

7. Firstly pass the colposcope lamp cable through the opening in the stand and then insert the connecting tube.
8. Hold the colposcope roughly at the height required as the working height and tighten the clamp nut on the clamp head:



9. Connect both the lamp cable plug and the mains plug to the power supply. Ensure that the lamp cable plug has a bayonet lock which first has to be inserted (10) and then tightened (11):



10. Fasten the lamp cable at the rear of the power supply using the cable ties. Bear in mind that you allow the cable sufficient play for height adjustment:

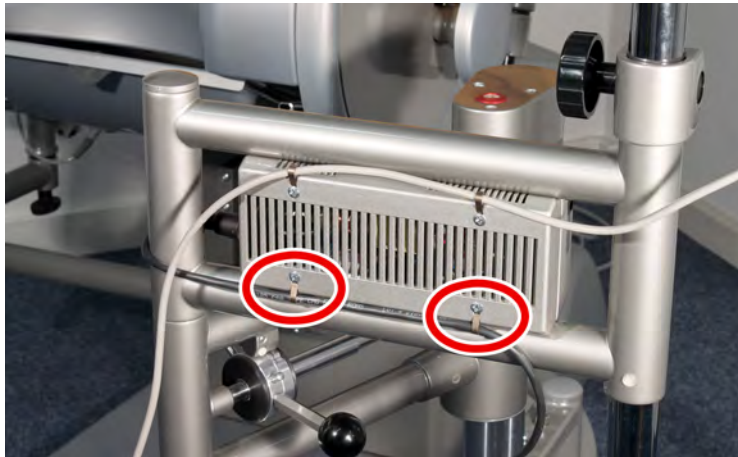

Swing-o-matic assembly:

The height adjustment depends on the chair manufacturer and model. Please contact our customer service team in this regard (see section 11 *Customer service*).

11. Move the colposcope to the later working position and lock the clamping lever:



12. The stand now has to be aligned vertically. To do so, loosen the set screws of the clamping jaws (12) and correct the position of the spring shaft. Check that the alignment is correct using the spirit level that is installed (13):





The tension of the tension springs is preset at the factory for weight compensation. Check the final tension nevertheless.

The tension is set correctly if the stand frame remains in a balanced state after removing the spacer block. If it still moves upwards, the tension has to be corrected.

13. Move the stand to the mid height for this purpose and lock the clamping lever.



CAUTION Risk of crushing through weight

While setting the spring tensioning the hex key can slip and the stand frame can drop down or accelerate upwards.

- ▶ Therefore lock the stand frame before removing the latch pin.



To set the spring tensioning, a screwdriver can be also used instead of a hex key.

14. Insert the hex key into one of the holes in the adjusting collar. Push it through completely.
15. Turn the hex key slightly against the spring tension (anticlockwise), hold the key in this position (14) and then pull out the latch pin (15):



16. Now turn the adjusting collar about half a turn against or with the spring tension:
 - ▶ **Against the spring tension (anticlockwise):**
The tension is increased, the frame moves upwards.
 - ▶ **With the spring tension (clockwise):**
The tension is decreased, the frame moves downwards.
17. Reinsert the latching pin, release the clamping lever and check whether the tension is now set correctly. Repeat the procedure as necessary.
 - ▶ The balance-o-matic stand is assembled.



In a non-active position or if outside the working position, the stand may be in what is referred to as the “park position” (folded-up). Up and down movement should be avoided in this position, as otherwise damage to the supports and the stand frame may result. Vertical movement may only be undertaken in the extended state.

6.3 Chair mounting – left assembly



Leisegang colposcopes can generally be mounted left or right on an examination chair; this does depend on the model of chair, however. For clarification, please contact your chair manufacturer.

For the conversion from right to left, proceed as described for left assembly (see section 6.1.4 *Left assembly*).

6.4 Conversion from chair to spider base mounting

The conversion of a balance-o-matic stand is described. But the description applies analogously for the swing-o-matic stand. A conversion set is required for conversion from chair to spider base assembly.

Conversion set delivery package



1	Adhesive	3	Conical insert
2	Cylinder screw M10x90	4	Hex key



Swing-o-matic stand conversion:

A suitable spider base column is also included in the conversion set for swing-o-matic stands.

1. Remove the colposcope from the stand and disassemble the stand from the examination chair.
2. Pull the rubber cap from the lower end of the balance-o-matic column.

3. Stick in the conical insert and leave the stand for at least 12 h:



4. Proceed as described in section 6.1.2 *Swing-o-matic stand* or 6.1.3 *Balance-o-matic stand*.

6.5 Special mounts



Please refer to the accompanying brief description for assembling special mounts.

6.6 Tray



- The tray is only mountable on the swing-o-matic or balance-o-matic stands, not on the upright stand.
- The tray can only be mounted on a swivel-o-mount stand on a chair under certain circumstances. Please contact our customer service team in this regard (see section 11 *Customer service*).

Prerequisite:

- ▶ The stand is mounted.
1. Attach the clamp on the spring shaft. If necessary, loosen the screws slightly:

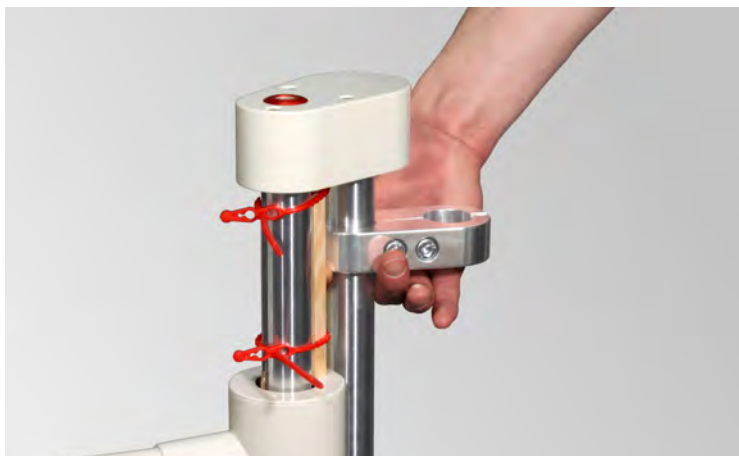

2. Insert the tray into the clamp opening. In doing so, place one hand under the clamp and use one of the supports to support the tray (1). Screw in both screws with the assembly key (2):



- ▶ The tray is mounted.

- ▶ *Support arm panel PC MWS for chair / spider base mounting*

6.7 Support arm panel PC MWS for chair / spider base mounting



- For chair mounting, a load-bearing capacity of 32 kg is required.
- With regard to spider base mounting, a spider base with a double counterweight must always be mounted.
- Please refer to the accompanying brief description for assembling the support arm.

6.8 Keyboard holder for panel PC



- Additional mounting of a keyboard holder is not possible when mounting the support arm on a Swing-o-matic stand on a spider base.
- Please refer to the accompanying brief description for mounting the keyboard holder.

6.9 1E LED Light – tilt handle

For packaging reasons, the tilt handle of the 1E LED Light colposcope model is delivered unmounted. Before attaching the colposcope on the stand, this tilt handle must firstly be screwed onto the underside of colposcope head.

1. Carefully lay the colposcope on a smooth surface with the eyepieces downward:



2. Place the lamp cable in the groove (1) of the tilt handle. Ensure that the cable has sufficient play for tilting the colposcope head.

3. Pass the guide pins (2) through the intended recesses and tighten the cylinder screw (3):

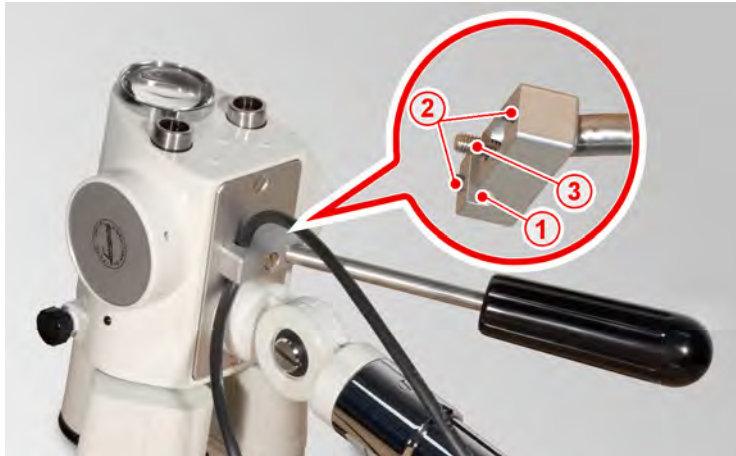

- ▶ The 1E LED Light is mounted. Now place the colposcope onto the erected stand as described in section 6.1 *Mounting on spider base* or 6.2 *Chair mounting* and continue assembling the stand.

6.10 Cameras for 3ML LED



Mounting external cameras is applicable for the colposcope models: 3ML LED, 3MLS LED 1", 3MLS LED ½", 3MLW LED.

6.10.1 Video camera

1. Screw the video tube on the video camera:



2. Pull off the cap from the colposcope camera port.

3. Insert the camera with the tube into the camera port to the stop (1). Keep the camera level and tighten the knurled screw (2):



4. Connect the camera with the laptop using the Mini-USB cable.
5. Check whether the video image is horizontal on the screen. If necessary, check the position of the camera by releasing the knurled screw.
 - ▶ The camera is now ready for use.

6.10.2 Canon EOS digital single lens reflex camera

Canon EOS delivery package



1	Camera housing	4	Charger with battery
2	Operating instructions	5	USB cable
3	Shoulder strap	6	AV cable



- Please note that a Canon lens, an HDMI cable and the photo tube are **not** included in the delivery package.
- The photo tube has to be ordered separately.



The 3ML LED, 3MLS LED 1", 3MLS LED ½" and 3MLW LED colposcope models firstly have to be prepared for use with a digital single lens reflex camera. A spacer is used for this purpose, which prevents the SLR camera hitting against the horizontal drive.

For packaging reasons, the spacer for the above models is delivered unmounted.

Mounting the spacer

Prerequisite:

- ▶ The colposcope is attached to the stand.
1. Using a screwdriver, release the M4x16 countersunk screw which is screwed into the guide piece:



2. Rotate the horizontal drive such that the colposcope is moved to the rear:



3. Take the spacer out of the bag and screw it onto the guide piece. Tighten the screw:



Mounting the SLR camera

4. Screw the T2 adapter onto the photo tube (1). Attach the photo tube to the camera bayonet (2). Ensure that the two red marking points coincide at the top. Turn the tube to the right until it locks in place (3):



5. Remove the cap from the colposcope camera port.
6. Insert the camera with the tube into the camera port to the stop (4). Keep the camera level and tighten the knurled screw (5):

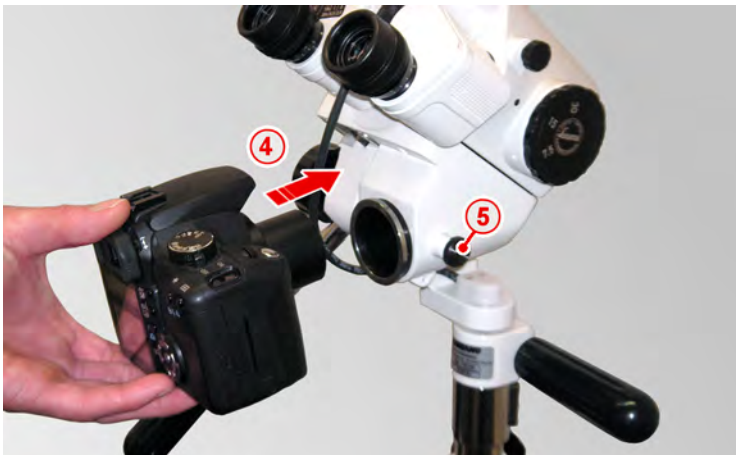

7. Check whether the camera is firmly seated in the camera port.
8. Connect the camera with the laptop using the USB cable.
 - The camera is now ready for use.

6.11 Photo/video adapter



The VID photo/video adapter is suitable for upgrading standard colposcopes.

Photo/video adapter delivery package

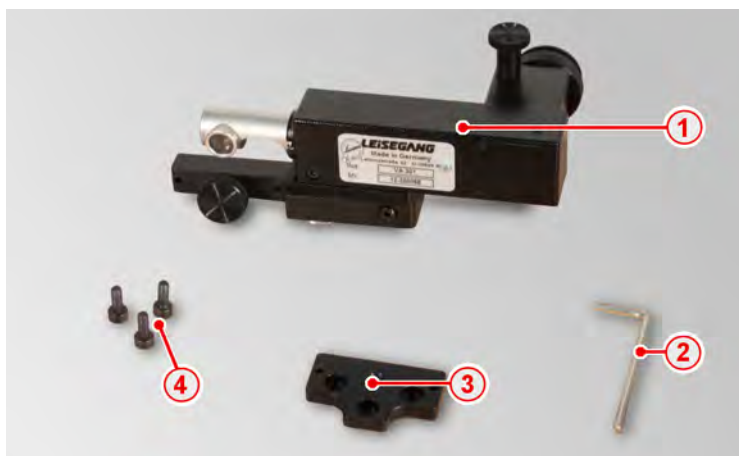

1	Photo/video adapter	4	Mounting plate
2	Hex key with grip	5	3x M4x10 hex keys
3	Hex key		

Photo/video adapter delivery package

1. Undo the blind plugs (1) from the threads using the hex key:

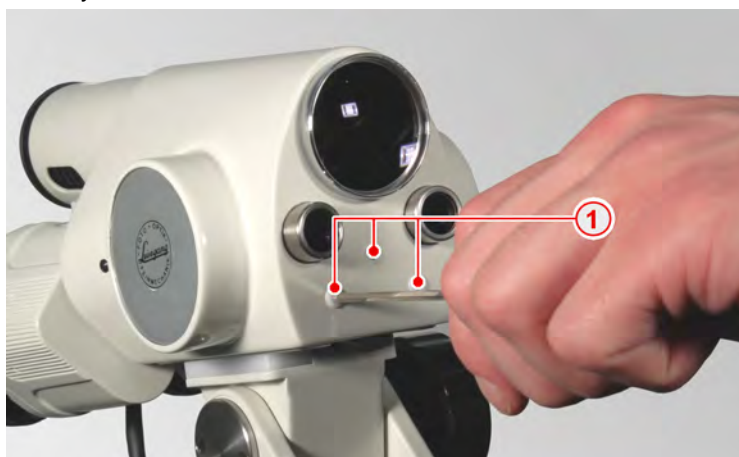

Assembly

► Photo/video adapter

2. Screw the mounting plate (2) onto the front surface of the colposcope head. To do so, screw the three M4 hex screws (3) into the thread intended for this purpose:



3. Position the traverse (4) of the photo/video adapter on the mounting plate in such a way that the two guide pins (5) extend into the respective holes. Firmly tighten the knurled screw (6):

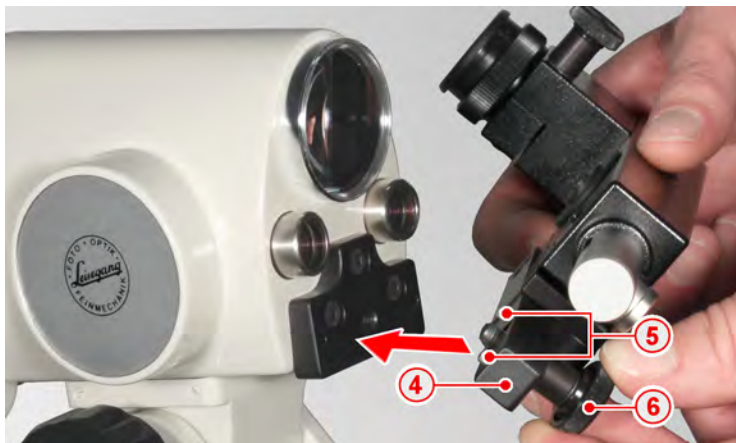

Connecting the video camera

4. Loosen the clamping screw (7) and pull out the C-mount tube (8). Remove the cap (9):



5. Remove the C-mount adapter from the video camera and hold the camera with the opening downward so no dust falls on the image sensor. Screw the C-mount tube firmly into the lens thread of the video camera (10).
6. Now push the C-mount tube back into the photo/video adapter to the stop and screw tighten the clamping screw (11):



7. Connect the video camera with the laptop using the Mini-USB cable.
8. Check whether the video image is horizontal on the screen. If necessary, correct the position of the camera using the clamping screw.

Adjustment of the photo/video adapter

9. Adjust the photo/video adapter such that the mid points of the colposcope image and the video image coincide. Make adjustments using the setting screw:
 - **Side adjustment:**
The photo/video adapter is swivelled to the right or left depending on the rotational direction of the setting screw for the side adjustment (12).
 - **Height adjustment:**
Loosening the clamping screw for the height adjustment (13) allows the lens tube (14) to be turned upwards or downwards. After adjusting, tighten the setting screw again:

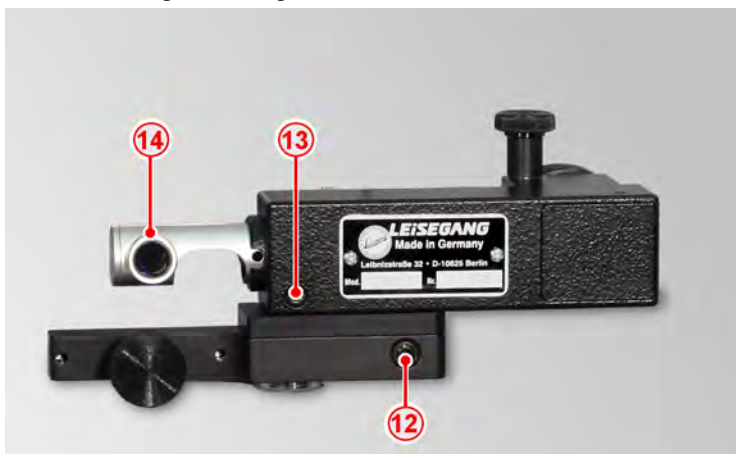

- The photo/video adapter is mounted and ready for use.

7 Care, maintenance, inspection

7.1 Care



WARNING

Injury through electric shock

The power supply is not protected against ingress of water. The ingress of liquid can cause an electric shock.

- ▶ Always pull out the mains plug before cleaning the device.

Colposcope, stand



CAUTION

Damage to the device

To avoid damage to the device, observe the following instructions for cleaning and disinfection:

Cleaning

- ▶ Regularly wipe the colposcope and stand with a damp (not wet) cloth. Use the cleaning solution in the normal dilution. Then dry the device with a dry, lint-free cloth. The following cleaning solutions can be used:
 - Universal cleaner
 - Hygiene cleaner
 - Surface cleaner

Disinfection

- ▶ Disinfect the device with common disinfectants in accordance with the applicable national hygiene standards and according to your internal hygiene plan. The following cleaning solutions can be used:
 - Ready-to-use alcohol-based disinfectant solution, e.g. 2-propanol (isopropanol)
 - Disinfectants based on amines, e.g. Chloramine-T
 - Disinfectants based on quats (quaternary ammonium compounds), e.g. dimethyldidecyl
 - Disinfectants based on active oxygen (peroxide), e.g. oxygen releasing compounds.
- ▶ The cleaning and disinfection solutions have to be used according to the manufacturer's specifications observing the recommended exposure times.

Observe the following cleaning and disinfection instructions to avoid damage to the device:

- ▶ A soap solution can be used to clean the lenses. Cloths suitable for use with optical devices should be used for drying.
- ▶ Do not use any abrasive or aggressive cleaning agents or disinfectants, as they may cause damage and corrosion.

Optics



CAUTION

Damage to the optics

Cleaning and disinfection is carried out as with the colposcope and stand. To avoid damage to the optics, observe the following instructions for cleaning:

- ▶ An aqueous soap solution can be used for cleaning the optics. Special optical cloths are suitable for wiping dry.
- ▶ Never use strong or corrosive cleaning agents and disinfectants! They can damage the surface.

Power supply



WARNING

Injury through electric shock

The power supply is not protected against ingress of liquids. The ingress of liquid can cause an electric shock.

- ▶ Avoid dripping and splashing water to prevent damage to the device.
- ▶ Do not spray the power supply with cleaning agents or disinfectants.

Further components (photo/video adapter, photo equipment, cameras)



CAUTION

Damage to the device

To avoid damage to the device, observe the following instructions for cleaning:

- Observe the same instructions as listed under *Colposcope, stand* and *Optics*.
- Do not attempt to clean the lenses **inside** the adapter or camera! This can lead to damage to the devices.

7.2 Maintenance



Leisegang colposcopes are easy to care for, contain no wearing parts and require no preventive maintenance within the defined expected service life.

7.3 Inspection



Before use, the devices should be checked by the user for visible damage. An inspection of electrical safety, in connection with a functionality test in accordance with the information provided by the standard IEC 62353, should be carried out after each repair and at least every **3 years**.

Leisegang Feinmechanik-Optik GmbH recommends a regular inspection of the device every **3 years**. Please contact your supplier for further information.

8 Repair

8.1 Replacing the tension wire (cable pull) on the spider base

Prerequisite:

- ▶ The balance-o-matic stand is mounted on a spider base or an examination chair. When mounted on a spider base, the castors must be locked to ensure stability during replacement.
- ▶ A screwdriver or hex key and possibly pliers are also required.

Removing the old tension wire



If the tension wire is not yet broken, the tension spring has to be relaxed.

1. Move the stand to the lowest position and lock the clamping lever.
2. Insert the hex key into one of the holes in the adjusting collar (1). Push it through completely. Turn the hex key anticlockwise slightly (2), hold the key in this position. Then pull out the latch pin (3):



3. Now turn the hex key clockwise and lock while repositioning the hex key each time with the latching pin. Keep turning until the tension wire is visibly tensioned.

► Replacing the tension wire (cable pull) on the spider base



- With older models, tensioning of the tension spring may require strength, as the adjusting collar is set in the tube with a very viscous grease.
- If the adjusting collar can no longer be moved ("seized up"), the stand has to be sent in for replacement of the tension wire. Please contact our customer service team in this regard (see section 11 *Customer service*).

4. Reinsert the latching pin.

5. Unhook the tension wire hook from the mandrel (4):



6. Unscrew the cap (5) together with the cover of the circular spirit level (6). Then unscrew the circular spirit level (7):



7. Loosen the grub screw slightly (8) and pull the old tension wire out of the hole in the worm wheel (9):



Replacing the worm wheel



The worm wheel has to be replaced if

- it is an older balance-o-matic with steel tension wire
- the worm wheel is damaged (e.g. if the grub screw can no longer be screwed in).

- 8.** Remove the sticker (**10**) from the clamp and loosen the two screws (**11**):

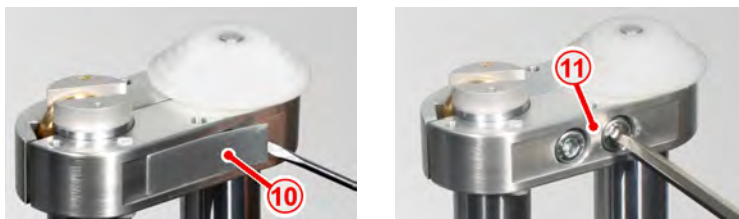

- 9.** Pull up the worm wheel and hold the tension spring (**12**) in place above the spring shaft (**13**) with pliers. Unscrew the worm wheel counter-clockwise. Use a cloth if necessary:



- 10.** Put the spring shaft back and screw the new worm wheel on.

Repair

► Replacing the tension wire (cable pull) on the spider base

11. Screw the clamp tight again. Take care that a distance of approx. 2 mm remains between the clamp and lower edge of the worm wheel:

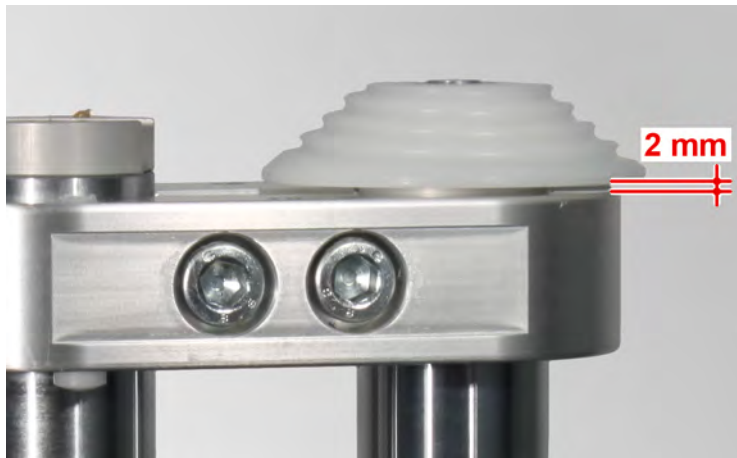

Inserting the new tension wire

12. Push the bent end of the new tension wire (14) into the hole. Press down slightly so the tension wire can run smoothly into the starting groove of the worm wheel:



13. Tighten the grub screw again. This secures the tension wire.
14. Hold the tension wire and twist it a couple of turns counter-clockwise. This prestresses the tension spring.

15. Guide the tension wire over the castor (15):



16. Mount the wire hook on the pin again. Take care not to kink the wire.

17. Carefully loosen the clamping lever and check whether the stand frame remains in a balanced state.

If not, the correct tension has to be reset using the adjusting collar.

- ▶ **Anticlockwise:**
The tension is increased, the frame moves upwards.
- ▶ **Clockwise:**
The tension is decreased, the frame moves downwards.

18. Screw back the circular spirit level and the cap.

- ▶ The tensioning wire is replaced.

8.2 Replacing the eyepiece cap upper parts

The upper parts of the eyepiece cap are easy to pull off and press on:



8.3 Replacing the fuse in the power supply



WARNING

Injury through electric shock

Reaching into the mains connector of the power supply can result in contact with live components.

- Remove the mains plug prior to replacing the fuse!

1. Pull the fuse holder (1) out of the mains connector (2). Use a screwdriver for this purpose. Replace the fuse (3):



2. Reinsert the fuse holder in the mains connector.
 - The fuse is replaced.

9 Spare parts

Item	Art. no.	Specification
Power supply LED	B0006300	100 V – 240 V, 50/60 Hz, 4 V, 20 W, CE marked, UL approved
Power supply LED	B0006400	For devices with magnification 3.75x/7.5x/15x 100 V – 240 V, 50/60 Hz, 3.2 V, 3 A
Tension wire with hook	B0000141	Spare tension wire for balance-o-matic stand
Worm wheel	E0000193	For replacement tension wires
Eyepiece cap upper parts	R0000604	For eyepieces
Fuse	K0000145	For power supply B0006300, 2A T250 V
Fuse	K0000146	For power supply B0006400, 5X20 2.00 A T
Device cable	K0000745	Device cable 2.50 m
Lamp optics D	B0000265	For magnification 7.5x/15x/30x
Lamp optics S	B0000258	For magnification 3.75x/7.5x/15x
Clamp nut	B0000001	For tilt
Clamp nut	B0000113	For clamp head
Double castor	K0000907	Polyamide, 75 mm, black, with brake
Double castor	K0000908	Polyamide, 50 mm, black
Double castor	K0000909	Polyamide, 50 mm, black, with brake



Please contact our customer service team should you wish to order spare parts (see section 11 *Customer service*).

10 Disposing of waste equipment

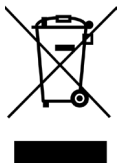

Countries of the European Union

- According to the EU directive on waste electrical and electronic equipment (WEEE) (2002/96/EC), waste electrical and electronic equipment must be disposed of separately. Therefore, do not dispose your old equipment with your normal household waste, but take it to your local collection site.
- You can also return your old equipment to your specialist dealer or to Leisegang. Further information on returning old equipment is available from your local authorities.

Countries outside of the European Union

- Other rules may apply in countries outside of the European Union.

11 Customer service

In case of technical problems, questions or complaints, please contact our Customer Service.

Leisegang Feinmechanik-Optik GmbH
Leibnizstr. 32
10625 Berlin

Tel: +49 30 319 009-0
Fax: +49 30 313 5992
E-mail: sales@leisegang.de
service@leisegang.de

In case of complaints, always keep the following information at hand:

- Order number
- Model number (**REF**) and
- Serial numbers (SN) of the components

The serial numbers are found on the respective type plates:



The type plates shown in the figures are examples.

12 Keyword index

A

Assembly	35
Left assembly	43

C

Care	64
Complaint	74
Customer service.....	74

D

Device description	10
Disposal	
packaging material	34
Disposal of waste equipment	73

E

Electromagnetic compatibility.....	30
------------------------------------	----

I

Inspection	66
------------------	----

M

Maintenance	66
Model number.....	29
Mounting	
chair	47
chair, left assembly.....	53
conversion from chair to spider base	53
photo/video adapter.....	61
SLR camera	58

special mounts	54
spider base	35
tray	55
video camera	57

P

Placement on the market.....	9
Precautions	8
Purpose.....	5

R

Repair	
replacement of the eyepiece cap upper	
parts	72
replacement of the fuse	72
replacement of the tension wire (cable	
pull)	67

S

Safety instructions.....	7
Spare parts	73
Spring tensioning, setting the tension 42, 52	

T

Technical data.....	15
Transport and storage.....	34

W

Warranty information.....	9
---------------------------	---

Issued by:

LEISEGANG Feinmechanik-Optik GmbH
Leibnizstrasse 32
D-10625 Berlin

Phone: +49 30 319 009-0
Fax: +49 30 313 5992
E-Mail: info@leisegang.de

www.leisegang.de

Copyright ©LEISEGANG Feinmechanik-Optik GmbH 2013.